

DRIVEGUARD™ INSTALLATION/OPERATION MANUAL

THIS MANUAL COVERS THE FOLLOWING SYSTEMS:

DRIVEGUARD™
DRIVEGUARD INTEGRATOR™
PIONEER™ Free Exit System

CONSUMER INFORMATION:

DATE PURCHASED: _____

DATE INSTALLED: _____

SERIAL NUMBER: _____

(Located on black relay on circuit board)

TABLE OF CONTENTS

Introduction1
 Serial Number1
 Installing Control Unit.....1
 Power and Battery Backup.....1
 Earth Ground1
 Trip-Test Button2
 Re-Trigger Hold-Off2
 Transient Suppression2
 Adjusting Sounder (Annunciator) Time2
 Adjusting Probe Sensitivity.....2
 Extra Set of Relay Contacts2
 Connecting to a Gate Operator2
 Annunciation in the Home when used with Gate.....3
 Integrating With a Security or Home Automation System ...3
 CT-6 Probe and Wire Check-out.....3
 System and Probe Don'ts3
 Location of CT-6 Probe4
 Installing CT-6 Probe and Cable4
 Connecting CT-6 Probe to Control Unit5
 Multi-Probe Assemblies5
 Phasing Probes.....5
 SD-6 Short Driveway Dual-Probe System.....5
 Connecting Other Sensing Devices to Control Unit6
 Installing Sounders (Annunciators)6
 Field Troubleshooting7
 Splicing Probe Cable8
 Warranty Information9
 Merchandise Return Information.....9
 Technical Specifications9

LIMITED THREE YEAR WARRANTY

All Cartell products are warranted against defects in material and workmanship for three years. This warranty does not cover defects caused by, but not limited to: acts of God, improper installation, abuse, fire and water damage, electrical surges, and damage to cable caused by slicing, pulling, tangling, or improper splicing.



RETURNING MERCHANDISE

If you're the end-user, please consult the dealer/installer who installed your Cartell system before attempting to return it. Dealer/Installer, please call Cartell at 717-532-0033 to troubleshoot the system over the phone and to receive a Return Merchandise Authorization (R.M.A.) number.

TECHNICAL SPECIFICATIONS — CONTROL UNIT

POWER REQUIRED:	8-31 VAC; 10-41 VDC (Issue 4) 12 VAC or 11-18 VDC (Issue 3)
STANDBY CURRENT:	Under 1 mA (board only, without sounder)
ALARM CURRENT:	30 mA max. (board only); 45 mA (with one sounder)
RELAY CONTACT RATING:	Double Pole, Double Throw 1st Pole: 12 VDC, 200 mA for remotes 2nd Pole: SPDT, 5 amps at 30 VDC
RELAY TIME:	1/2 to 15 seconds
TEMPERATURE RANGE:	0° F - 140° F
DIMENSIONS:- complete unit / board only:	5 1/2 in. x 5 1/2 in. x 2 in. / 4 in. x 3 1/4 in.
WEIGHT - complete unit / board only:	2.5 lbs. / 1/4 lb.

TECHNICAL SPECIFICATIONS — SENSOR PROBE

TEMPERATURE RANGE:	-40° F - +250° F
PROBE DIMENSIONS:	16 1/2 in. x 1 3/8 in. diameter
WEIGHT:	3.5 lbs. with 100' cable
OTHER:	500 to 800 ohms coil resistance depending on length of cable

tests bad, go to the sensor probe itself and cut the wire one foot from the probe and retest it. If the probe still tests bad, then you may need to replace it with a CT-6-10 probe. Splice the CT-6-10 to the cable using the 3-M splice kit (see "Splicing Probe Cable" below).

To test the CT-2B control unit, do the following:

1. Disconnect the probe wires from the terminal strip;
2. Set the probe sensitivity "B" setting to half way (vertical); and then
3. Push the TRIP TEST button

No response indicates possible transformer or power source (across terminals 1 and 2) failure or component failure on the circuit board. If the board does respond, wait at least 10 seconds. Then take a wire and short terminals 10 and 12. If the board does not trip, lightning damage to the probe input to the amplifier is indicated.

If either the probe or control unit fails the test, contact the dealer/installer who installed your system. If you are a dealer/installer, call Cartell's technical staff using the 800 number. Further instructions will be given or authorization to return the ostensibly defective product for testing and repair. If the probe is bad there is no way of repairing it. It is recommended that all repairs be returned directly to Cartell and not be sent through a distributor.

SPlicing SENSOR PROBE CABLE

The cable supplied with your system is coated with polyurethane because it will bond with epoxy and make a sealed splice. If you purchase your own cable, make sure it is polyurethane coated or it will not splice. Improper cable splices will cause false alarms and failures. For proper splicing, follow the instructions below.

Two items are necessary when splicing, both available from Cartell: First, a two-wire shielded direct burial cable (unshielded cable and PVC jacketed cable will not give proper splices). Second, an underground splice kit (made by 3M, part #82-F1; Cartell's part number is CA-1). The following instructions assume you have these products.

1. See Figure A. Strip the outer jacket on one cable back 10 inches and cut the RED and BLACK leads to 3 inches, leaving the SHIELD drain wire the full 10 inch length. Strip the outer jacket off the mating cable back 3 inches and strip the jacket of the RED and BLACK lead of both cables back 1/2 inch. Twist the BLACK to BLACK and RED to RED and solder the connections.

2. See Figure B. Trim the RED and BLACK joints and tape for proper insulation. Twist the 3 inch SHIELD drain wire to the 10 inch SHIELD drain wire and solder the connection. DO NOT cut off the excess SHIELD drain wire.

3. See Figure C. Wrap aluminum foil around the splice area (to properly shield it). Wrap the 10 inch SHIELD drain wire tightly around the outside of the foil and solder it to itself in order to hold it in place. This procedure insures that any signal to the splice SHIELD will drain to ground and thus prevent false alarms.

4. See Figure D. Place an underground splice kit potting container around the spliced cable and epoxy, following the kit instructions carefully.

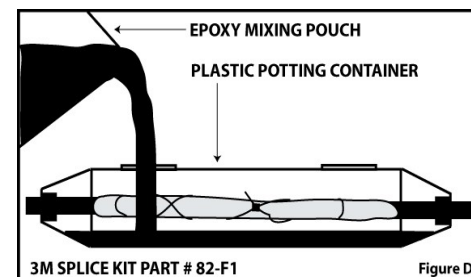
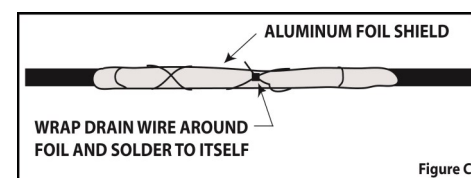
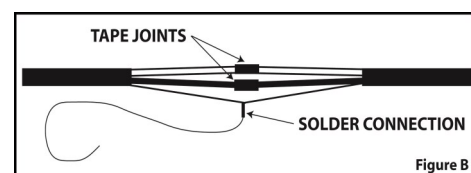
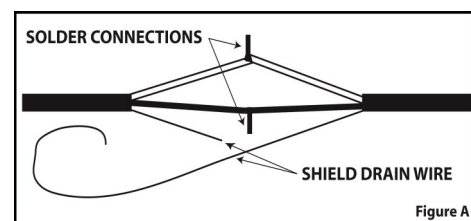

DRIVEGUARD™, DRIVEGUARD INTEGRATOR™, and PIONEER™ Free Exit System

Note: the CT-2BG control unit (part of the PIONEER™ Free Exit System) is the same as the CT-2B except the circuit board has been conformal coated and therefore suitable for installation outdoors in a weather-proof box or gate operator.

INTRODUCTION

Thank you and congratulations on purchasing the most professional vehicle detection system available! It has been manufactured in order to give years of trouble-free service. However, if it should need servicing, please consult the dealer/installer who installed your system.

Read these instructions completely. It is recommended that each system be bench-tested by the dealer/installer before installation as a standard practice. It is also recommended that the dealer/installer become acquainted with the CT-2B control unit and sensor probe in the shop; make all adjustments and settings; and study all system functions. If there are any questions or problems, contact Cartell's technical staff at 717-532-0033.

SERIAL NUMBER:

Attached to the circuit board relay is a sticker with a set of numbers and letters. This series of numbers and letters reveal the specific unit, its year of manufacture, its issue number and ends with the serial number (see illustration).

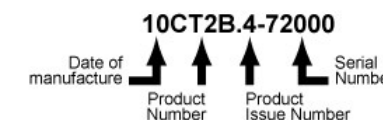

When calling Cartell for technical help, please have these numbers handy so that your call may be handled as intelligently and quickly as possible.

INSTALLING CONTROL UNIT

Install the control unit in a dry, weatherproof building away from heavy electrical motors, radio transmitters, main power service, or any equipment that may introduce electrical or R. F. noise. Install control unit in a sealed box when used in a corrosive atmosphere such as an animal barn or chemical plant.

For unheated buildings or other outdoor applications (such as gate operators), use the CT-2BG control unit, as it is conformal coated and not susceptible to moisture caused by temperature changes. However, it should still be installed in a sealed, weather-proof box or in the gate operator.

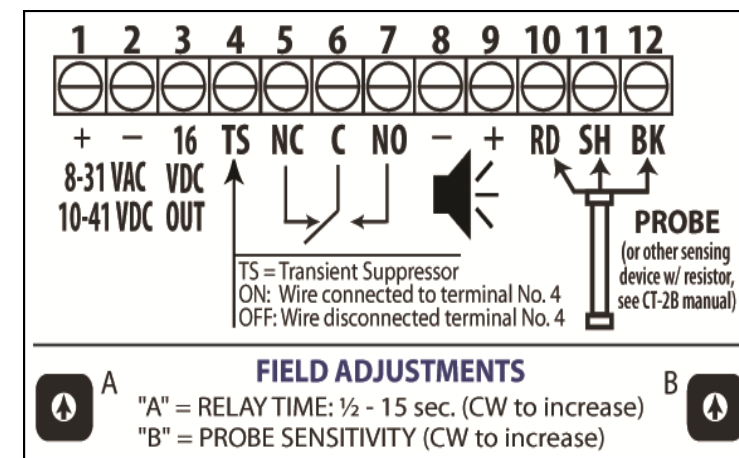

Figure 1

POWER AND BATTERY BACKUP

See Figure 1. The control unit operates on 8-31 VAC or 10-41 VDC (version 4). Hook up the 12 VAC transformer as shown in Figure 1. Built-in battery chargers do not come with this system. If battery backup is desired, any 12 VDC power pack can be used. Hook up as shown for 12 VDC operation. Any 12 VDC power source may be used.

EARTH-GROUND

No grounding is necessary.

TRIP-TEST BUTTON

See Figure 1 on page 1. The TRIP-TEST button, located center right on the circuit board, is a tool to evaluate most of the control electronics and to help in setting the relay time.

Set the probe sensitivity potentiometer "B" to the halfway point (vertically). Push the trip-test button on and off quickly. DO NOT hold the button on. The signal generated simulates that of a detected vehicle. No response indicates component failure on the circuit board or failure of the power supply or a shorted probe or cable. Disconnect probe wires from terminal strip and try again.

Special Note: After using the TRIP TEST button to test the circuit board, wait at least ten seconds before re-testing. This allows time for the re-trigger hold-off timer to reset.

RE-TRIGGER HOLD-OFF

The re-trigger hold-off circuit allows both for a shorter annunciator time and minimizes irritating multiple alarms. However, if you are working with an application not conducive to this re-trigger hold-off feature, call Cartell's technical staff at 717-532-0033 for the disconnect procedure.

TRANSIENT SUPPRESSION

The CT-2B control unit transient suppressor circuit is already connected. The transient suppressor is activated when the wire is connected to terminal No. 4. This circuit will reduce false alarms caused by lightning. If difficulty occurs when setting the probe sensitivity, disconnect the wire from terminal No. 4 to de-activate the transient suppressor.

ADJUSTING SOUNDER (ANNUNCIATOR) TIME

See Figure 1 on page 1. This function controls the amount of time the customer desires the sounder(s) to stay on. It may be adjusted to stay on anywhere from 1/2 to 15 seconds. To adjust, use the potentiometer "A" (CW to increase time). Push the trip-test button to hear your adjustment. Keep adjusting until the desired time is achieved.

ADJUSTING PROBE SENSITIVITY

See Figure 1 on page 1. Probe sensitivity is set at the factory and does not usually need to be adjusted. Factory setting allows a single standard probe to cover a 12 foot wide driveway when installed beside it (see "Installing CT-6 Probe and Cable" on page 4). Increasing the sensitivity above the factory setting is not recommended unless the probe is located in a low sensitivity area.

When the probe is placed in the center of the drive, sensitivity may be decreased considerably allowing the probe to be installed closer to highway traffic, power lines, etc.

To adjust probe sensitivity, turn the potentiometer "B" fully counter clockwise and adjust clockwise in small increments. Use a small, slow moving vehicle to test sensitivity. Have it pass the probe and adjust the potentiometer between each pass. Stop adjusting at the point where the small car trips the system each time it passes the probe.

EXTRA SET OF RELAY CONTACTS

See Figure 1 on page 1. The annunciator relay has a second set of free SPDT contacts that connect to terminals No. 5, 6, and 7. The contacts may be used to trip a dialer, alarm panel, home automation panel, and transmitter, etc.

CONNECTING TO A GATE OPERATOR

See Figure 1 on page 1. The CT-2BG control unit can be used to trigger a gate operator by using the free set of relay contacts #6 (Common) and #7 (Normally Open). These contacts should be

of the mute cycle. To restore sound, hold "PROG" button down and push the "DOWN" button two times in quick succession as before. The LED will stop blinking when sound is restored to its previous setting.

ADJUST TIMING (OPTIONAL)

The default timing for the CT-A1 is set at the control unit (see "Adjusting Sounder (Annunciator) Time" on page 2). However, if a longer sounding time is desired for individual CT-A1's, it can be lengthened by turning the pot on the sounder's circuit board counter-clockwise (CCW).

CONNECTING CT-A1 SOUNDER TO CT-2B CONTROL UNIT

See Figure 4.

Connect wires to CT-A1 first, then to the CT-2B.

- ◆ At CT-A1, connect a wire to terminal "V." At CT-2B, test resistance as noted above and connect to terminal 3.
- ◆ At CT-A1, connect another wire to terminal "G." At CT-2B, test resistance and connect this wire to terminal 8.

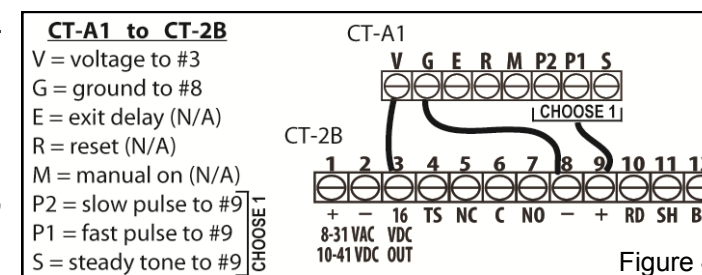

- ◆ At CT-A1, connect a third wire to terminal "S" (for steady tone) or "P1" (for fast pulsating tone) or "P2" (for slow pulsating tone). At CT-2B, test resistance and connect this wire to terminal 9.

NOTE: The three extra functional buttons on the CT-A1 ("ON", "RESET", "EXIT") are non-functional when used with the CT-2B. They should be ignored.

For using CT-A1 with a two or three-driveway system, see manual that came with CT-A1.

INSTALLING CT-11 SOUNDER

See Figure 1 on page 1. Please read the instructions in the introduction. First make the connections at the CT-11 plate and then to the control unit as follows:

Connect one colored wire to the terminal marked "-". At the control unit, test the resistance as noted above. Then proceed to connect this wire to terminal 8.

Connect another colored wire to the terminal marked "+". At the control unit, test the resistance as noted above. Then proceed to connect this wire to terminal 9.

INSTALLING AA-1 SOUNDER

See Figure 1 on page 1. Connect the RED lead to the terminal marked SON on the sounder. Connect the BLACK lead to GND on the sounder. At the control unit, test the resistance RED to BLACK as noted above. If resistance proves correct, at the control unit connect the RED lead to terminal No. 9. Twist the BLACK lead to the SHIELD wire and connect to terminal No. 8.

FIELD TROUBLESHOOTING

Cartell does not provide circuit diagrams or service manuals. However, we try very hard to provide fast repair service and 717-532-0033 phone number by which technical support may be reached.

Before calling Cartell, there are some simple procedures you can follow. The vast majority of all service problems result from a fault with the control unit and not from the probe.

Disconnect the probe wires from the control unit and perform the resistance tests listed in "CT-6 Probe and Wire Check-Out" on page 3. The resistance tests will determine the health of the probe and wire.

If the probe reading indicates a bad probe, do not immediately dig it up. Rather, if there is a splice in the line, locate it and cut the wire on the probe side of the splice. Then retest it. If the probe still

CONNECTING OTHER SENSING DEVICES TO CONTROL UNIT

See Figure 1 on page 1.

The CT-2B is engineered to accept other sensing devices in conjunction with or exclusive of the CT-6 sensor probe. You may use as many and as varied sensing devices as you like. To do so, you will need the following:

1. A sensing device with a normally open, floating, dry relay contact
2. A 500 - 1000 ohm resistor

To connect your sensing device to the CT-2B, attach one side of the device to terminal 10, the other side to terminal 12 and place a 500 - 1000 ohm resistor across those two terminals.

INSTALLING SOUNDERS (ANNUNCIATORS)

The CT-2B control unit supports up to twelve (12) sounders.

MOUNTING

Install the sounders in a single-gang electric box for flush mounting.

WIRE

Use CAT-5 wire. To avoid corrosion, solder-tin the ends of the wires before connecting to the sounder and control unit. Always connect the wire to the sounder first and then to the control unit.

WIRE CHECK-OUT

After connecting wires to the sounder, and before connecting to the control unit, systematically measure the resistance between each wire with every other wire. **Resistance should never be less than 75 ohms.** Resistance less than 75 ohms shows damage to the wire between control unit and sounder (e.g., a staple through the wire) and will damage the power supply if it is connected to the control unit.

CT-A1 SOUNDER FEATURES AND INSTALLATION (REPLACES FC-9, CT-8, CT-8A SOUNDERS)

THREE TONES

The CT-A1 allows three tones: steady, slow-pulse, fast-pulse. It is suggested the installer sample the tones for the customer to choose. To hear a sample of the steady tone, push the button marked "PROG." To hear a sample of the slow-pulse tone, push the button marked "DOWN." To hear a sample of the fast-pulse, push the button marked "UP." Note: power must first be applied to the CT-A1 before it will sound.

PROGRAMMING VOLUME

To adjust volume, keep the button marked "PROG" pushed in the entire time you are increasing or decreasing volume (it will continue to sound as long as it is pushed in, demonstrating adjusted volume).

With "PROG" pushed in, push the button marked "UP" to increase volume one increment. Keep "PROG" pushed in, wait one second, and push "UP" again. Repeat until desired volume is reached.

With "PROG" pushed in, push the button marked "DOWN" to decrease volume one increment. Keep "PROG" pushed in, wait one second, and push "DOWN" again. Repeat until desired volume is reached.

Note: when highest or lowest volume setting is reached, the LED will blink once.

MUTING SOUNDER

To mute sounder, keep "PROG" button pushed in and push the "DOWN" button two times in quick succession (in less than one second). The LED will begin blinking and continue blinking the duration

connected to the momentary input terminals of the gate operator, typically the key pad input or RF radio receiver input. The time adjustment for the relay adjustment "A" should be set at its minimum setting (see "Adjusting Sounder (Annunciator) Time" on page 2). Longer relay time may be necessary for those installations where the vehicle stops, then restarts near the sensor probe after the gate is open.

ANNUNCIATION IN THE HOME WHEN USED WITH GATE

In addition to tripping the gate operator, the CT-2BG can be used to trip a sounder inside the home. Run a wire to the gate operator from the home and use the extra set of relay contacts (terminals 8 and 9, see Figure 1 on page 1) to trip the sounder inside the home. For more information, contact technical support by calling Cartell at 717-532-0033.

INTEGRATING WITH A SECURITY OR HOME AUTOMATION PANEL

See Figure 1 on page 1.

You will need two things to have a successful installation:

1. The manual for your home automation or security panel
2. A resistor (consult your manual for the correct size)

The CT-2B has a floating, dry relay contact.

Note: Use the power supply that came with the CT-2B to power it rather than relying on the home automation or security panel for power.

Use two wires to connect the CT-2B to a single zone on your panel. If your system's contacts are normally closed, use terminals 5 & 6 on the CT-2B. At your system's panel, place a resistor between the terminals in parallel (see your H.A. manual for resistor size).

If your H.A. contacts are normally open, use terminals 6 & 7 on the CT-2B and place a resistor between the terminals in series (see your H.A. manual for resistor size)

CT-6 PROBE AND WIRE CHECK-OUT

It is advisable to check the sensor probe assembly before and after installation in the earth. Use a good multimeter. With the probe wire disconnected from the control unit, measure the resistance between the RED and BLACK leads. It should read between 500 and 800 ohms for a single probe. Additional probes on the system will add approximately 620 ohms each. The reading should be stable with zero fluctuations.

The resistance between the RED lead and the SHIELD, or the BLACK lead and the SHIELD should be millions of ohms. The resistance between the SHIELD drain wire and earth-ground should be millions of ohms.

While making measurements to the SHIELD drain wire, do not touch the bare wire or the multimeter leads with your fingers as that will spoil the readings.

If a bad probe is indicated, it may be an improper wire splice (see "Splicing Probe Cable" on page 8). Before digging up the system, dig up the wire splice only, cut the wire on the probe side and retest the system. If the bad readings still exist, cut the cable several feet from the probe and retest. See "Splicing Probe Cable" on page 8 for proper splicing. Call Cartell for further troubleshooting before digging up the system.

SYSTEM AND SENSOR PROBE DON'TS (NOTE: NOT APPLICABLE TO CT-6 PROBE CABLE)

- DO NOT use double sided tape to mount the circuit board on another surface (if you decide to take it out of its case). Note: control boards and cases are sold separately.

- DO NOT bury the probe within 6 to 10 feet of a buried power or telephone line.
- DO NOT bury the probe within 6 to 10 feet of a buried invisible dog fence.
- DO NOT bury the probe within 10 feet of a natural gas line.
- DO NOT bury the probe within 20 feet of a power pole with a transformer attached to it.
- DO NOT bury the probe within 100 feet of railroad traffic.
- DO NOT bury the probe within 200 feet of sub-station type overhead power lines.
- DO NOT mount the probe vertically when used for above-ground applications.

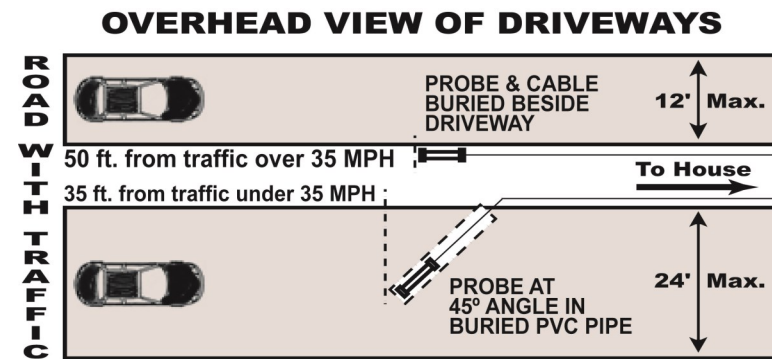

Figure 2

LOCATION OF CT-6 PROBE

See Figure 2. The sensing range of a probe buried beside the driveway is 5 to 8 feet with a small car going 5 MPH. Taking the width of the car and the sensing range, this system covers a 12 foot wide driveway. Buried in the middle of the driveway, this system covers a 24 foot wide driveway (see "Installing Sensor Probe and Cable," below).

The probe should be at least 35 feet back from a street on which cross traffic is going under 35 MPH and at least 50 feet back from a street on which cross traffic is going over 35 MPH. If the probe is installed in the center of a 12 foot wide driveway, it can be 20 feet or 35 feet back from traffic respectively. (This is made possible by adjusting the probe's sensitivity. See "Adjusting Probe Sensitivity" on page 2.)

Stationary steel near the probe, but not over the probe, will not affect its operation. The probe can be placed in a PVC pipe under the steel-reinforced grid of a concrete roadway without affecting its operation.

Probes installed above ground should be mounted no higher than 2 feet above the road surface. If probe is attached to a wall or post, it should be mounted parallel to the ground and with the driveway. Rule of thumb: the vehicle must approach one end of the probe, not both at the same time. If a car approaches both ends of the probe (i.e., it is installed across, and not parallel with, approaching traffic) the signal will be cancelled.

In drive-up window applications, install the probe at least 15 to 20 feet before the window.

INSTALLING CT-6 PROBE AND CABLE

See Figure 2. Typically, the probe is buried 6-10 inches below ground, beside, and parallel to, the driveway. It is advisable to bury 6-10 feet of extra cable with the probe (coiled up) for future maintenance or relocation.

When installing the probe in existing pavement, bore a 1.5 inch diameter hole vertically, 18 inches deep. Slice the pavement from the bored hole to the driveway edge to accommodate the cable. Install the probe and cable and seal with silicon.

When installing the probe within a dirt or gravel driveway, first bury a 2 inch schedule 80 PVC pipe in the center of the driveway, 6-8 inches deep, and diagonally at a 45 degree angle (see Figure 2 on page 4). Slide the probe and cable to the end of this pipe, putting the probe in the middle of the driveway. This will make it easily retrievable in the future.

When installing in new construction, bury the 2 inch PVC pipe under the driveway as described above. Then pour cement or asphalt the drive. Insert the probe and cable after landscaping is complete to prevent possible damage to the cable.

The probe cable is direct burial and does not require conduit. Depth of burial depends on lawn conditions. In cultured grass, bury the cable 2-3 inches deep. The root system of the grass will capture the cable for life. Use a lawn edger to slice a 1/4 inch wide trench across the lawn to the location of the control unit. Push the cable to the bottom of the slice, fill, and tamp. In uncultured field grass or in soil without cultured grass, bury the cable at least 6-8 inches deep.

When installing the cable through woods or above ground, run it in PVC pipe for mechanical protection, as animals will chew through the cable if it is exposed.

When pulling the cable through conduit or PVC pipe, it is important that every inch of cable be liberally lubricated. Use a wire lubricant, and pull only 100 feet or less at one time. The cable is coated with polyurethane and therefore has extremely high traction. This can cause a tremendous drag when not lubricated; enough to inconspicuously snap the wire inside the rubber casing. Therefore, make sure you lubricate it when pulling it through conduit or PVC pipe.

Also, the polyurethane coating on the probe cable demands that extreme care be taken when unrolling it. To unroll, put your arm through the center of the roll, remove the tape, and unravel the roll one wrap at a time. Once you begin unrolling the cable, do not lay it down before you are finished lest it becomes irreparably tangled.

SPECIAL NOTE: The shielded cable can be buried in the same trench (not conduit) with power, telephone and water lines, if codes permit. Consult local and national codes.

CONNECTING CT-6 PROBE TO CONTROL UNIT

See Figure 1 on page 1. At the control unit, hook up the RED probe wire to terminal No. 10; connect SHIELD (Drain) wire to terminal No. 11; connect the BLACK wire to terminal No. 12.

MULTI-PROBE ASSEMBLIES

See Illustration at right. The CT-2B system can support up to four standard sensor probes without loss of sensitivity when wired in series. The probes should be hooked up as shown in the illustration at right. Solder and tape all inter-connections Solder-tin the leads before connecting to terminals 10, 11, and 12.

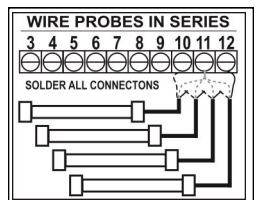

PHASING PROBES

Phasing of multi-probe assemblies is important when a probe is placed on both sides of the same driveway, or several probes are linked together to cover a large area. Phasing is not important in installations where a vehicle does not pass between two probes, such as probes used on separate driveways or when several probes are linked together at greater than 50 foot intervals. The phase output of the probe is controlled at the time of manufacturing.

SD-6 SHORT DRIVEWAY DUAL-PROBE SYSTEM

The SD-6 double-probe system installation instructions are shipped with the SD-6 dual-probe set. Only one SD-6 system can be used with the CT-2B control unit.